



Cambridge International Examinations
Cambridge International General Certificate of Secondary Education

PHYSICS

0625/21

Paper 2 Multiple Choice (Extended)

October/November 2016

45 minutes

Additional Materials: Multiple Choice Answer Sheet
Soft clean eraser
Soft pencil (type B or HB recommended)

* 2 1 1 1 7 5 4 9 2 8 2 *

READ THESE INSTRUCTIONS FIRST

Write in soft pencil.

Do not use staples, paper clips, glue or correction fluid.

Write your name, Centre number and candidate number on the Answer Sheet in the spaces provided unless this has been done for you.

DO NOT WRITE IN ANY BARCODES.

There are **forty** questions on this paper. Answer **all** questions. For each question there are four possible answers **A, B, C** and **D**.

Choose the **one** you consider correct and record your choice in **soft pencil** on the separate Answer Sheet.

Read the instructions on the Answer Sheet very carefully.

Each correct answer will score one mark. A mark will not be deducted for a wrong answer.

Any rough working should be done in this booklet.

Electronic calculators may be used.

Take the weight of 1.0 kg to be 10 N (acceleration of free fall = 10 m/s^2).

The syllabus is approved for use in England, Wales and Northern Ireland as a Cambridge International Level 1/Level 2 Certificate.

This document consists of **16** printed pages.

- 1 The graph shows how the distance travelled by a vehicle changes with time.

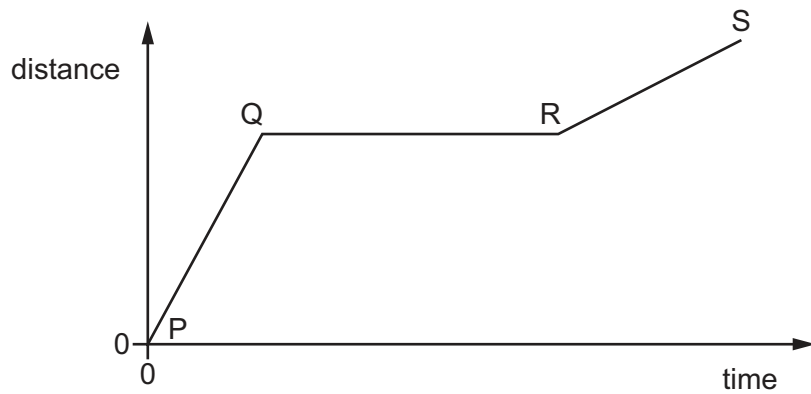

Which row describes the speed of the vehicle in each section of the graph?

	P to Q	Q to R	R to S
A	constant	zero	constant
B	constant	zero	decreasing
C	increasing	constant	decreasing
D	increasing	zero	constant

- 2 A stone falls freely from the top of a cliff. Air resistance may be ignored.

Which graph shows how the acceleration of the stone varies with time as it falls?

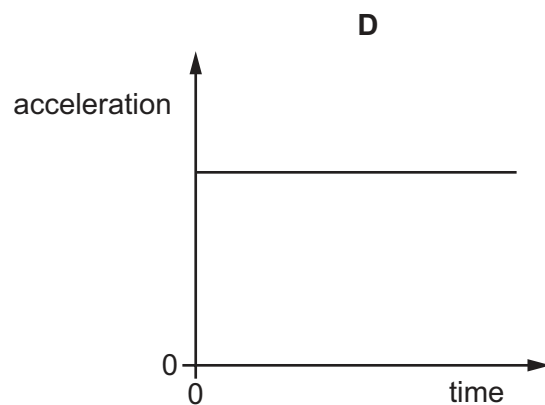
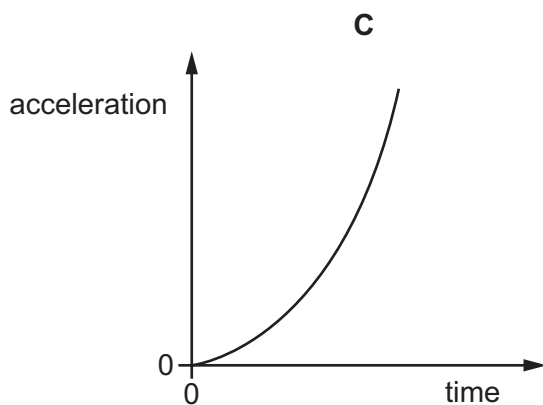
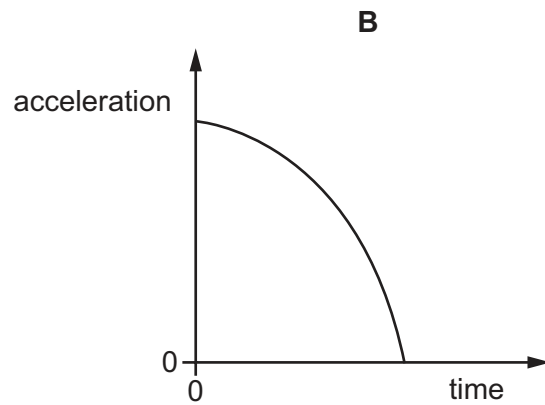
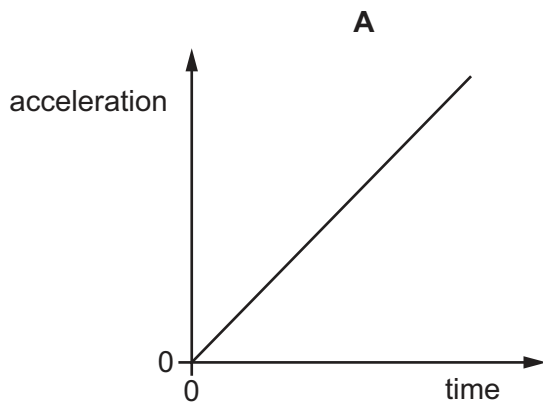

- 3 A car travels along a horizontal road in a straight line. The driver presses the accelerator to increase the speed of the car.

The speed-time graph for the car is shown.

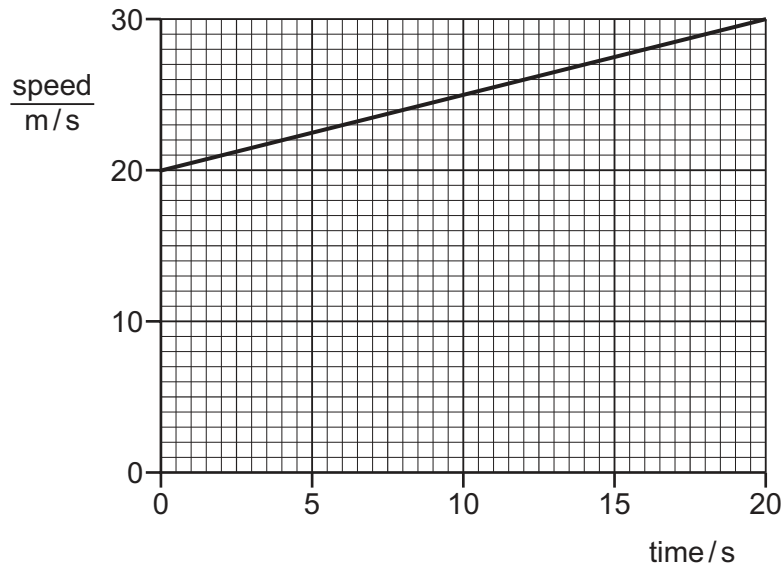

What is the acceleration of the car?

- A** 0.50 m/s^2 **B** 1.00 m/s^2 **C** 1.50 m/s^2 **D** 2.00 m/s^2
- 4 A spaceship approaches the Earth from deep space. Near the Earth, a force on the spaceship causes it to have weight. This causes it to change its speed and direction.

Which type of force causes the spaceship's weight, and which property of the spaceship resists its change in speed and direction?

	force that causes weight	property that resists change in speed and direction
A	gravitational	mass
B	gravitational	volume
C	magnetic	mass
D	magnetic	volume

- 5 The diagrams show an empty rectangular box, and the same box filled with liquid.

The box has a mass of 60 g when empty. When filled with liquid, the total mass of the box and the liquid is 300 g.

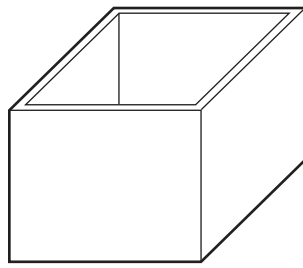

empty box
60 g

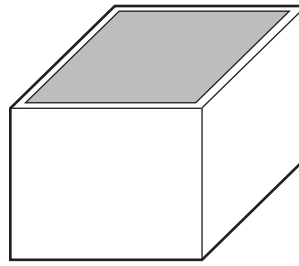

box filled with liquid
300 g

The density of the liquid is 1.2 g/cm^3 .

What is the volume of the liquid in the box?

- A 50 cm^3 B 200 cm^3 C 250 cm^3 D 300 cm^3
- 6 An object travels in a circular path at constant speed.

Which statement about the object is correct?

- A It has changing kinetic energy.
 B It has changing momentum.
 C It has constant velocity.
 D It is not accelerating.
- 7 Which diagram shows the magnitude and direction of the resultant R of the two forces F_1 and F_2 ?

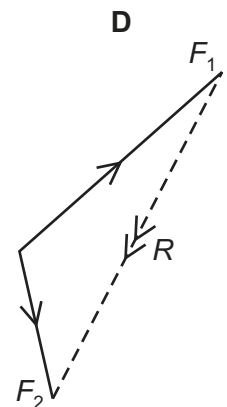
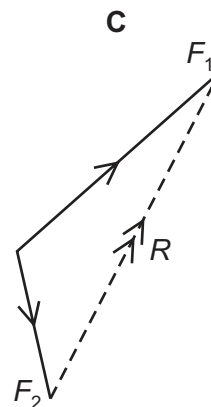
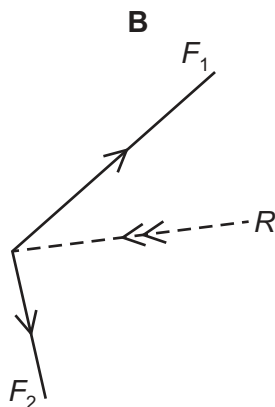
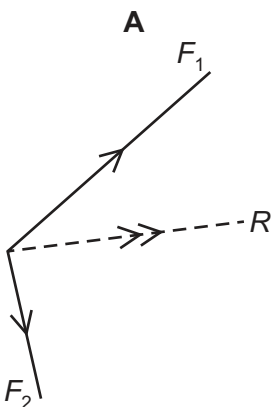

- 8 Two cars, P and Q, have different masses and different speeds as shown.

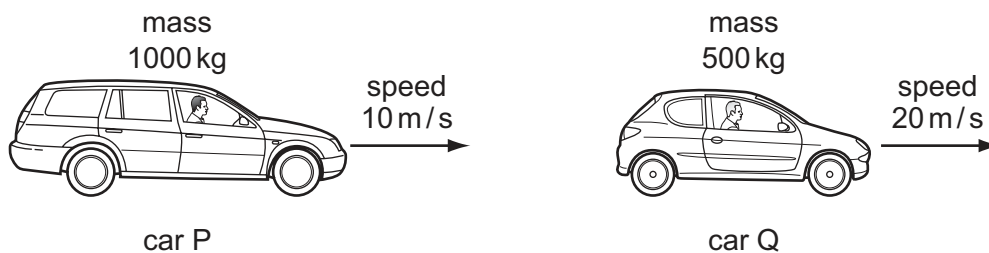

Which row correctly compares the momentum and the kinetic energy of P with the momentum and the kinetic energy of Q?

	momentum	kinetic energy
A	P greater than Q	P equal to Q
B	P equal to Q	P equal to Q
C	P equal to Q	P less than Q
D	P less than Q	P greater than Q

- 9 A car of mass 800 kg travels over a hill of height h .

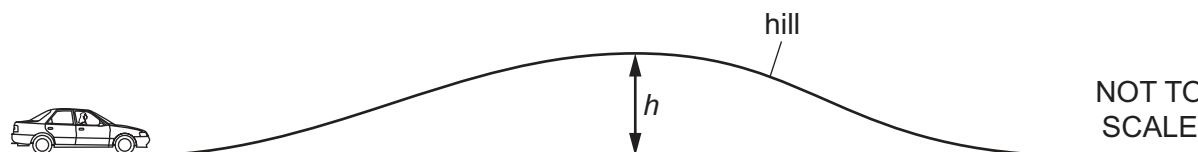

By travelling to the top of the hill, the car gains 40 000 J of gravitational potential energy.

The gravitational field strength g is 10 N/kg.

What is the height h of the hill?

- A** 5.0 m **B** 20 m **C** 50 m **D** 500 m
- 10 A lamp has a power input of 5.0 W. It wastes 1.0 W of power heating the surroundings.
What is the efficiency of the lamp?
- A** 20% **B** 50% **C** 80% **D** 120%
- 11 The box contains the names of eight different energy resources.

natural gas	geothermal	solar	waves
hydroelectric	oil	wind	coal

How many of these energy resources are renewable?

- A** 3 **B** 4 **C** 5 **D** 6

- 12 The diagram shows a dam holding back water.

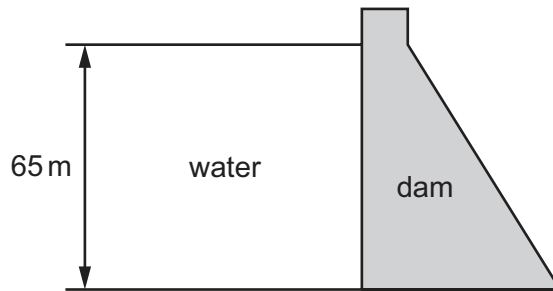

The depth of the water is 65 m.

The density of the water is 1000 kg/m^3 . The gravitational field strength g is 10 N/kg .

What is the pressure exerted at the base of the dam due to the water?

- A** 15.4 Pa **B** 154 Pa **C** 65 000 Pa **D** 650 000 Pa
- 13 Air is trapped in a cylinder by a piston. The original volume of the trapped air is V and the original pressure of the trapped air is P . The piston is pushed to the left. The temperature of the gas does not change.

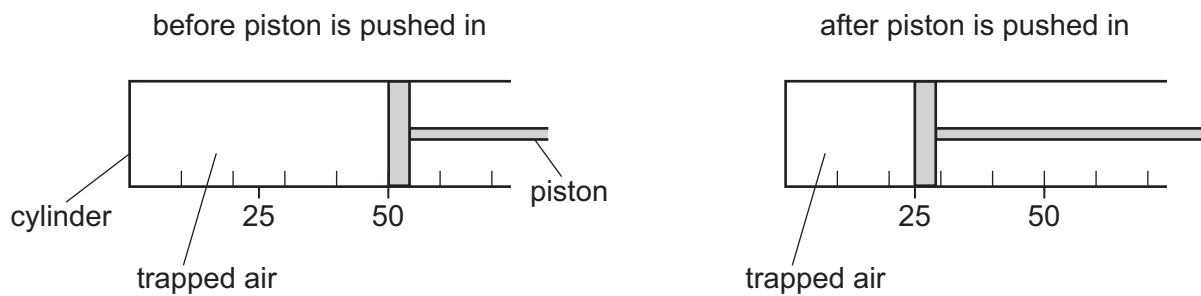

What is the new volume and what is the new pressure of the trapped air?

	new volume	new pressure
A	$2V$	$\frac{P}{2}$
B	$2V$	$2P$
C	$\frac{V}{2}$	$\frac{P}{2}$
D	$\frac{V}{2}$	$2P$

- 14 When a liquid evaporates, some of its molecules escape from the surface and the temperature of the liquid changes.

Which row describes the escaping molecules and the change in temperature of the liquid?

	escaping molecules	temperature of the liquid
A	less energetic	goes down
B	less energetic	goes up
C	more energetic	goes down
D	more energetic	goes up

- 15 A gas at a constant temperature is in a container of fixed volume. The gas exerts a pressure on the walls of the container. The pressure is caused by the gas molecules striking the walls.

Which statement about the gas molecules when they strike the walls is correct?

- A** The average kinetic energy of the gas molecules changes.
- B** The average momentum of the gas molecules changes.
- C** The average speed of the gas molecules changes.
- D** The chemical energy of the gas molecules changes.
- 16 A piece of melting ice at 0°C and a beaker of boiling water are both in a laboratory. The laboratory is at 20°C .

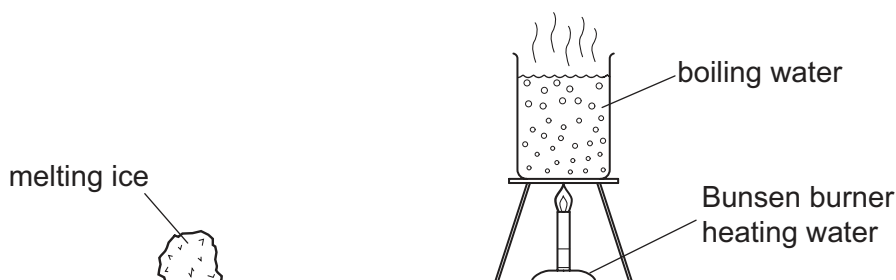

What is happening to the temperature of the melting ice and what is happening to the temperature of the boiling water?

	temperature of melting ice	temperature of boiling water
A	constant	constant
B	constant	increasing
C	increasing	constant
D	increasing	increasing

- 17 The diagram shows a liquid-in-glass thermometer.

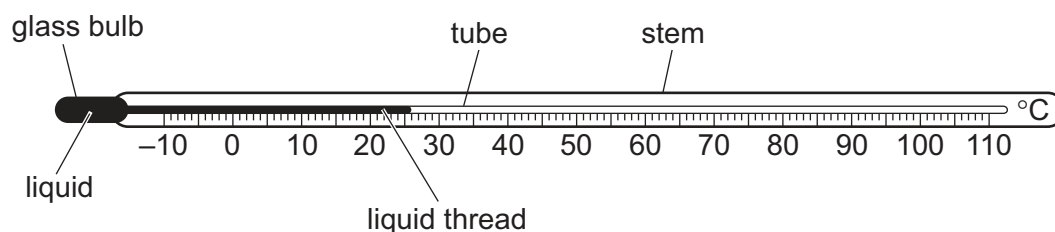

Which feature would give a thermometer with an increased range?

- A** a smaller internal diameter of the tube containing the liquid thread
- B** a thinner glass bulb
- C** a larger length of the tube and stem
- D** a larger volume of the liquid
- 18 A copper container of mass 0.20 kg contains 0.10 kg of water.
- The specific heat capacity of copper is $385 \text{ J}/(\text{kg } ^\circ\text{C})$ and the specific heat capacity of water is $4200 \text{ J}/(\text{kg } ^\circ\text{C})$.
- How much energy, in joules, is needed to raise the temperature of the copper container and the water by 10°C ?
- A** $(0.20 \times 385 \times 10) - (0.10 \times 4200 \times 10)$
- B** $(0.20 \times 385 \times 10) + (0.10 \times 4200 \times 10)$
- C** $(0.10 + 0.20) \times \left(\frac{4200 + 385}{2} \right) \times 10$
- D** $(0.10 + 0.20) \times (4200 + 385) \times 10$
- 19 The thermal transfer of energy through a copper rod involves electrons.
A second process is also involved.

What is this method of thermal energy transfer, and what is the second process?

	method	second process
A	conduction	density change
B	conduction	lattice vibration
C	convection	density change
D	convection	lattice vibration

- 20 The diagrams show four spherical objects at the same temperature. Two of the objects are small and two are large. Two of the objects are white and two are black.

Which object emits infra-red radiation at the greatest rate?

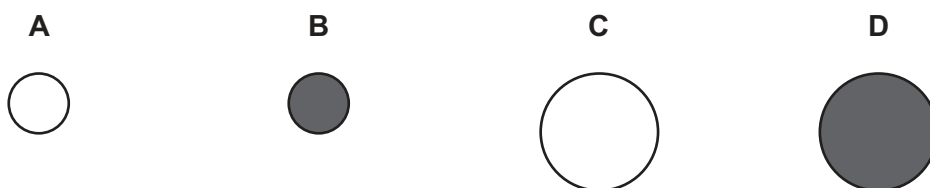

- 21 The diagram represents plane wavefronts being diffracted by passing through a gap in a barrier.

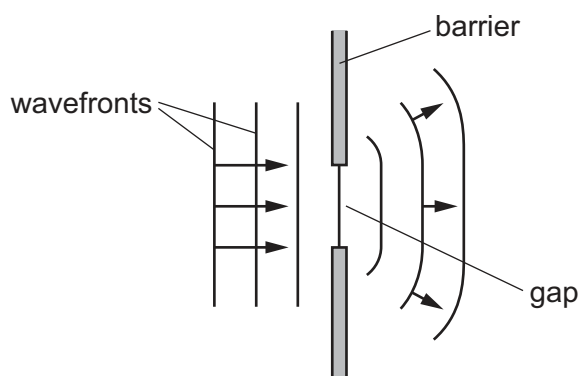

Which pair of changes **must** increase the amount of diffraction that occurs?

- A** decrease the wavelength and decrease the size of the gap
B decrease the wavelength and increase the size of the gap
C increase the wavelength and decrease the size of the gap
D increase the wavelength and increase the size of the gap
- 22 An image is formed by a plane mirror. A second image is formed by a lens used as a magnifying glass.

Which row states the nature of each of these images?

	plane mirror	magnifying glass
A	real	real
B	real	virtual
C	virtual	real
D	virtual	virtual

- 23 Light travelling at a speed of 3.0×10^8 m/s strikes the surface of a glass block and undergoes refraction as it enters the block.

The diagram shows a ray of this light before and after it enters the block.

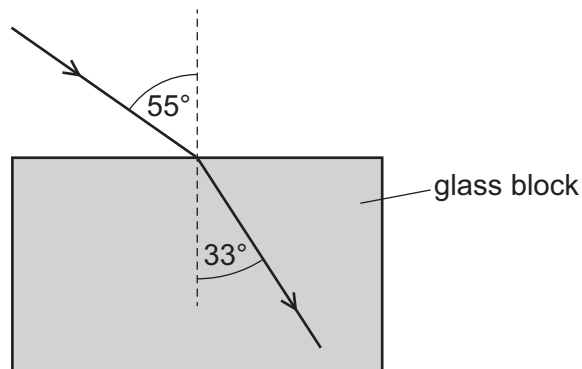

What is the speed of light in the glass?

- A 1.8×10^8 m/s
B 2.0×10^8 m/s
C 4.5×10^8 m/s
D 5.0×10^8 m/s
- 24 Radiation from which part of the electromagnetic spectrum is used in the remote controller for a television?
- A infra-red waves
B microwaves
C radio waves
D ultraviolet waves
- 25 A girl notices that, when she shouts into a cave, she hears an echo.
- Which wave property causes the echo?
- A diffraction
B dispersion
C reflection
D refraction

26 The diagrams represent the displacement in four different sound waves. All the diagrams are drawn to the same scale.

Which diagram represents the sound with the highest pitch?

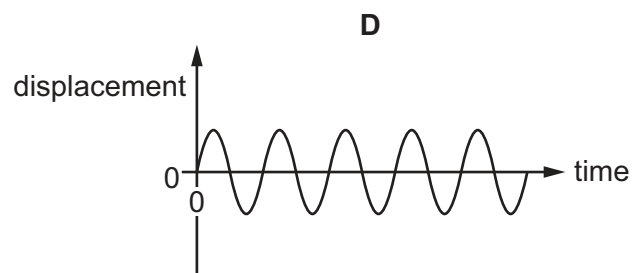
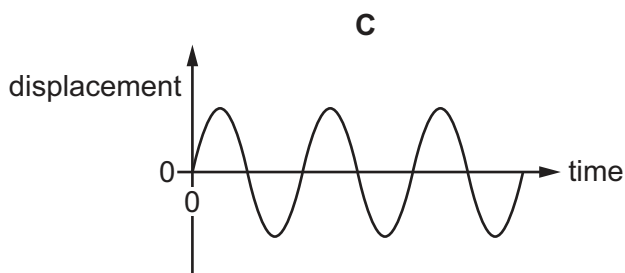
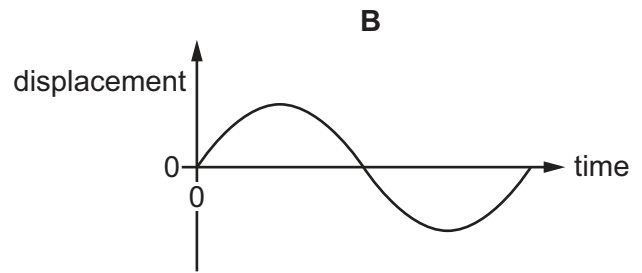
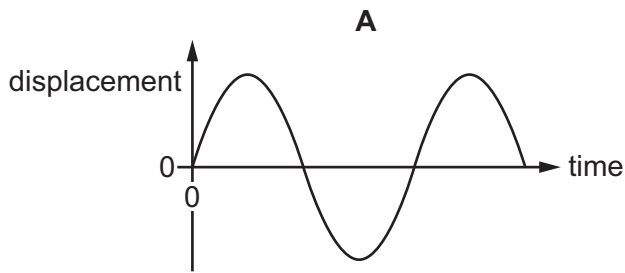

27 A student suggests three methods for demagnetising a piece of steel.

- 1 placing it in an east-west direction and hammering it hard
- 2 placing it in an east-west direction and heating it until red hot
- 3 removing it slowly from a coil carrying alternating current

Which of the methods will demagnetise the piece of steel?

- A** 1 only **B** 2 only **C** 3 only **D** 1, 2 and 3

- 28 In two separate experiments, a magnet is brought near to an unmagnetised iron bar. This causes the bar to become magnetised.

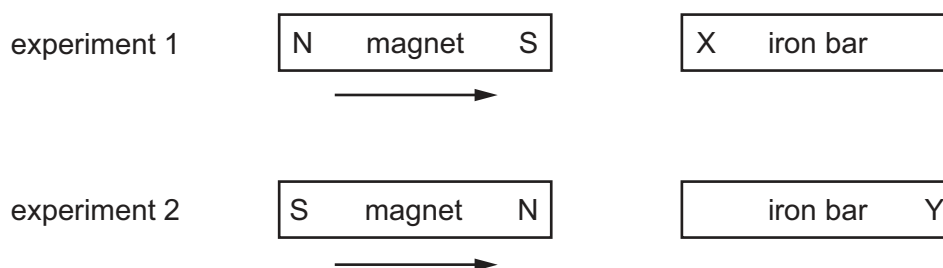

Which magnetic pole is induced at X and at Y?

	pole induced at X	pole induced at Y
A	N	N
B	N	S
C	S	N
D	S	S

- 29 A polythene rod is rubbed with a cloth. The rod becomes positively charged because of the movement of charged particles.

Which row gives the name of these charged particles, and the direction in which they move?

	charged particles	direction of movement
A	electrons	from cloth to rod
B	electrons	from rod to cloth
C	protons	from cloth to rod
D	protons	from rod to cloth

- 30 The diagram shows a lamp in a circuit.

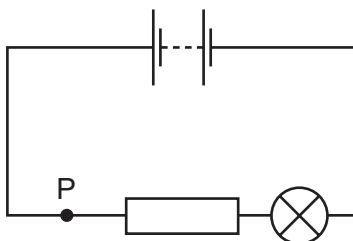

Which change to the circuit would increase the current in the lamp?

- A adding another resistor in parallel with the one in the circuit
 - B adding another resistor in series with the one in the circuit
 - C decreasing the electromotive force (e.m.f.) of the battery in the circuit
 - D moving the lamp to point P in the circuit
- 31 A $12.0\ \Omega$ resistor and a $6.0\ \Omega$ resistor are connected in parallel.

Another $6.0\ \Omega$ resistor is then connected in series with the parallel combination.

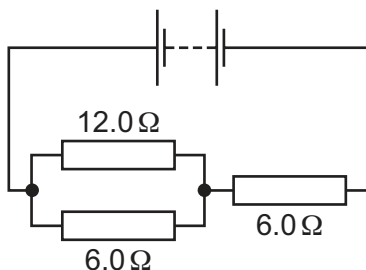

What is the combined resistance of all three resistors?

- A $8.0\ \Omega$
 - B $10\ \Omega$
 - C $15\ \Omega$
 - D $24\ \Omega$
- 32 The circuit shows a $12\ \text{V}$ battery connected to a lamp of resistance $3.0\ \Omega$.

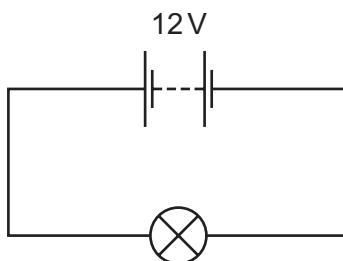

How much energy is transferred to the surroundings by the lamp in 2.0 minutes?

- A 48 J
- B 96 J
- C 2880 J
- D 5760 J

- 33 The diagram shows a circuit containing a battery, a resistor with high resistance, a switch and a lamp.

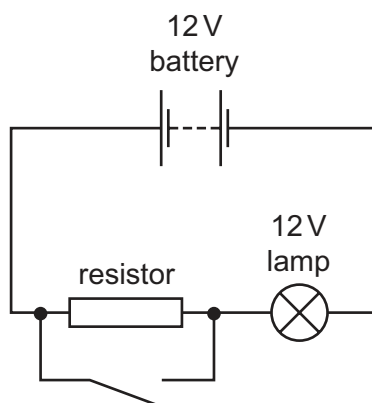

Initially the switch is open.

What happens to the lamp when the switch is closed?

- A It glows more brightly.
 - B It glows less brightly.
 - C It goes out.
 - D Its brightness does not change.
- 34 This is the truth table for a logic gate.

input 1	input 2	output
0	0	1
0	1	1
1	0	1
1	1	0

Which symbol represents the logic gate?

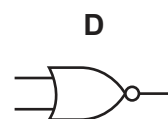
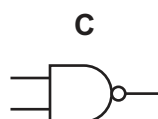
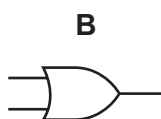
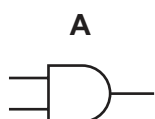

- 35 Why is a fuse used in an electrical circuit?

- A so that the current can have only one value
- B to prevent the current becoming too large
- C to provide a path to earth if a fault occurs
- D to save electrical energy

36 An electric current can produce a heating effect and a magnetic effect.

Which row shows the effect that a relay uses and one application of a relay?

	effect used by a relay	one application of a relay
A	heating effect	allowing a small current to switch on a large current
B	heating effect	changing the voltage of an a.c. supply
C	magnetic effect	allowing a small current to switch on a large current
D	magnetic effect	changing the voltage of an a.c. supply

37 A very important experiment improved scientists' understanding of the structure of matter.

The experiment involved α -particles being fired at a thin gold foil.

What happened?

- A** All the α -particles were absorbed by the nuclei of the gold atoms.
- B** All the α -particles were unaffected by the gold atoms.
- C** Some of the α -particles were attracted by the neutrons in the nuclei of the gold atoms.
- D** Some of the α -particles were repelled by the protons in the nuclei of the gold atoms.

38 What is meant by nuclear fusion?

- A** the emission of an electron from a nucleus
- B** the emission of two protons from a nucleus
- C** the joining together of two nuclei
- D** the splitting of a nucleus into two smaller nuclei

39 A nucleus undergoes radioactive decay. The proton number increases by one. The nucleon number does not change.

Which particle has been emitted in this decay?

- A** a neutron
- B** a proton
- C** an α -particle
- D** a β -particle

- 40 Radioactive source S emits α -particles, β -particles and γ -rays. A detector is placed 5 cm away from S. A thin sheet of paper is placed as shown in the diagram.

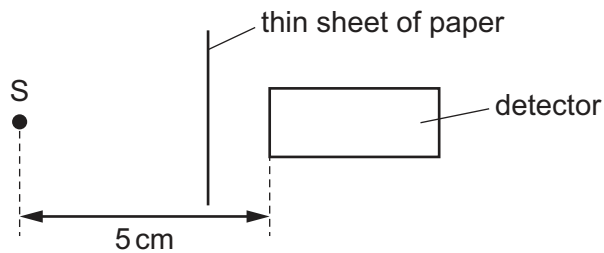

Which emissions from the source can be detected?

- A α -particles and β -particles only
- B α -particles and γ -rays only
- C β -particles and γ -rays only
- D α -particles, β -particles and γ -rays

Permission to reproduce items where third-party owned material protected by copyright is included has been sought and cleared where possible. Every reasonable effort has been made by the publisher (UCLES) to trace copyright holders, but if any items requiring clearance have unwittingly been included, the publisher will be pleased to make amends at the earliest possible opportunity.

To avoid the issue of disclosure of answer-related information to candidates, all copyright acknowledgements are reproduced online in the Cambridge International Examinations Copyright Acknowledgements Booklet. This is produced for each series of examinations and is freely available to download at www.cie.org.uk after the live examination series.

Cambridge International Examinations is part of the Cambridge Assessment Group. Cambridge Assessment is the brand name of University of Cambridge Local Examinations Syndicate (UCLES), which is itself a department of the University of Cambridge.